

LAMPIRAN – LAMPIRAN

Lampiran 1. Denah Bendung Kamijoro

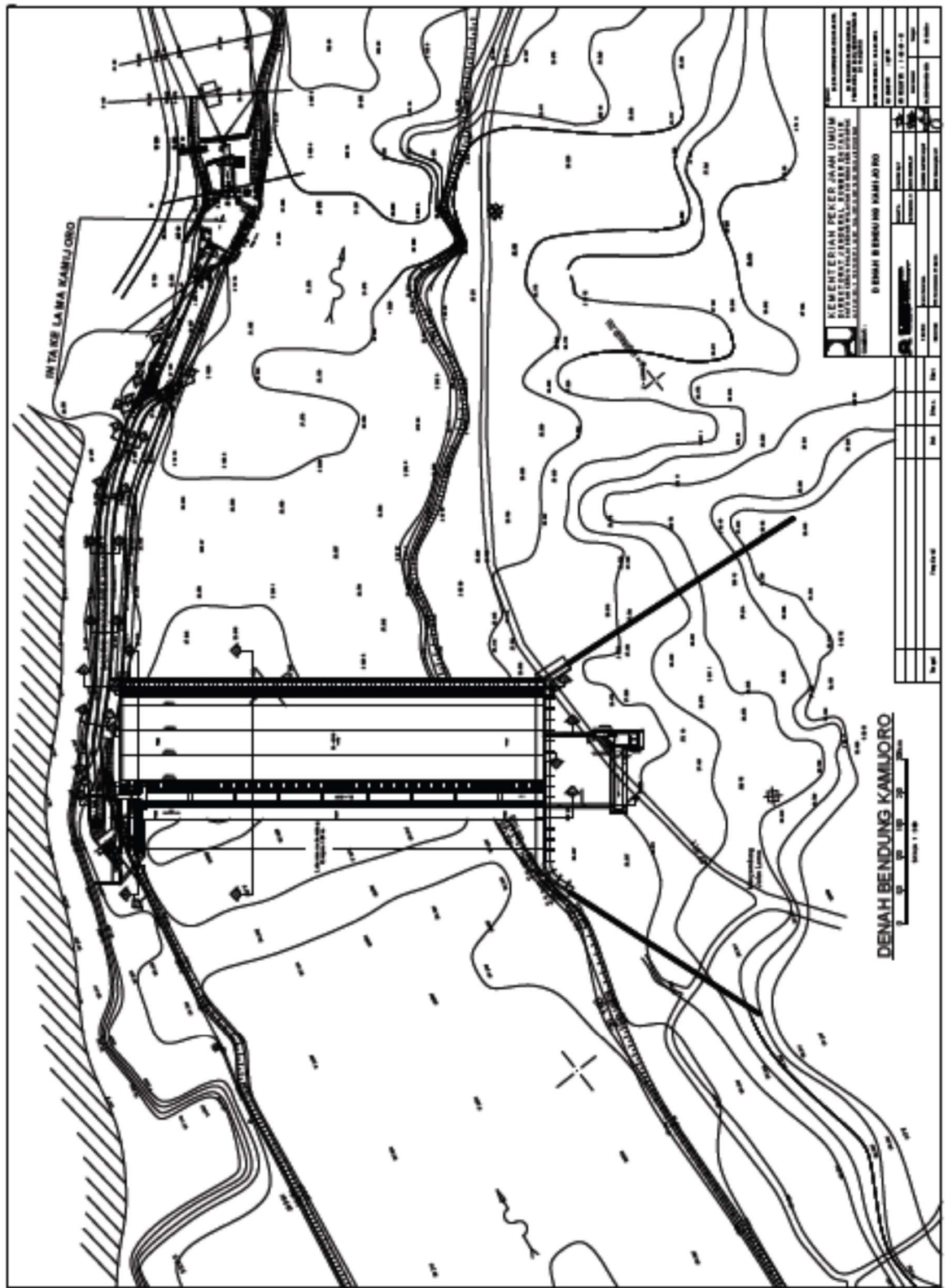

Lampiran 2. Potongan A-A Bendung Kamijoro

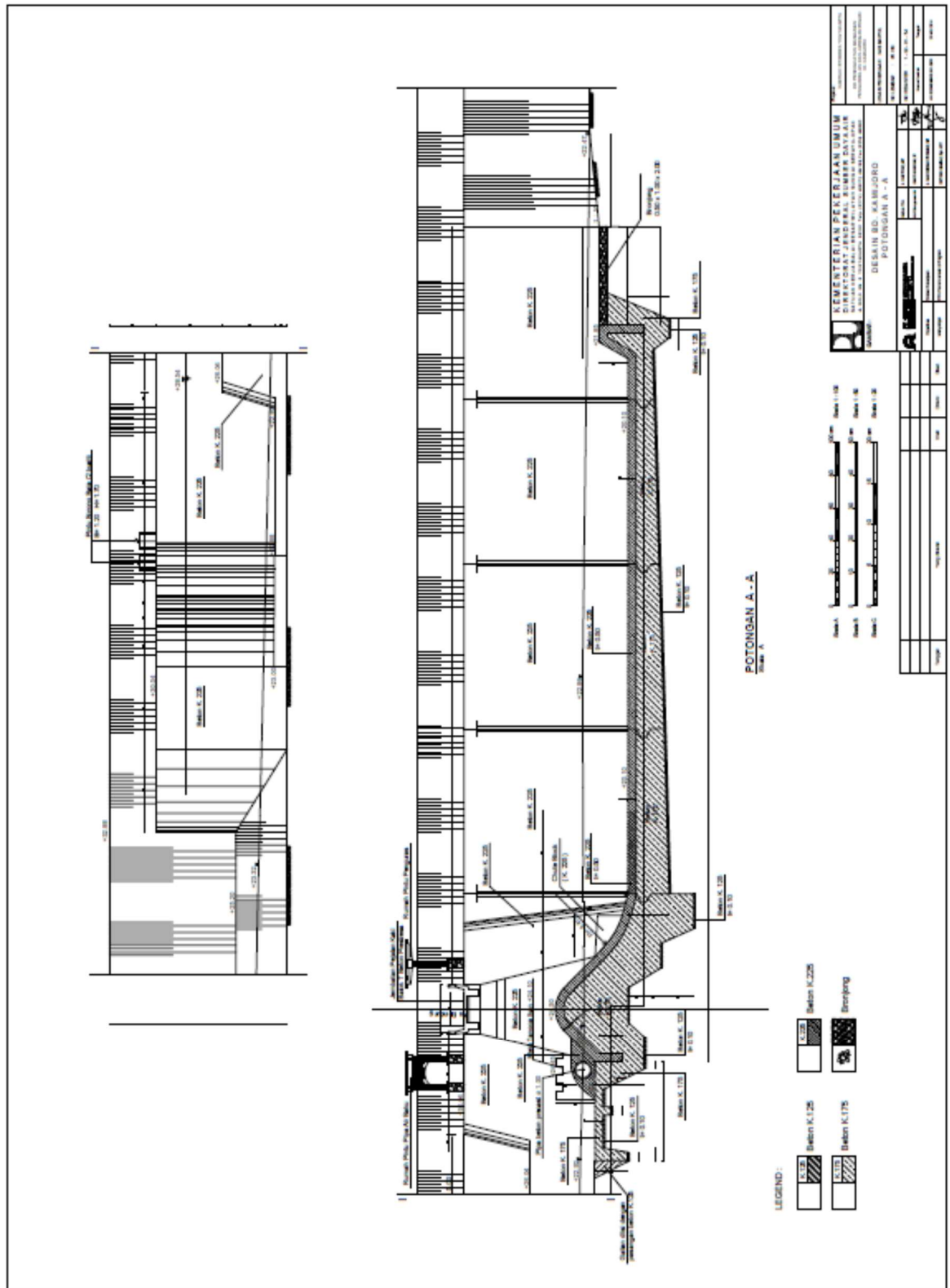

Lampiran 5. Gaya gempa dan berat sendiri bendung

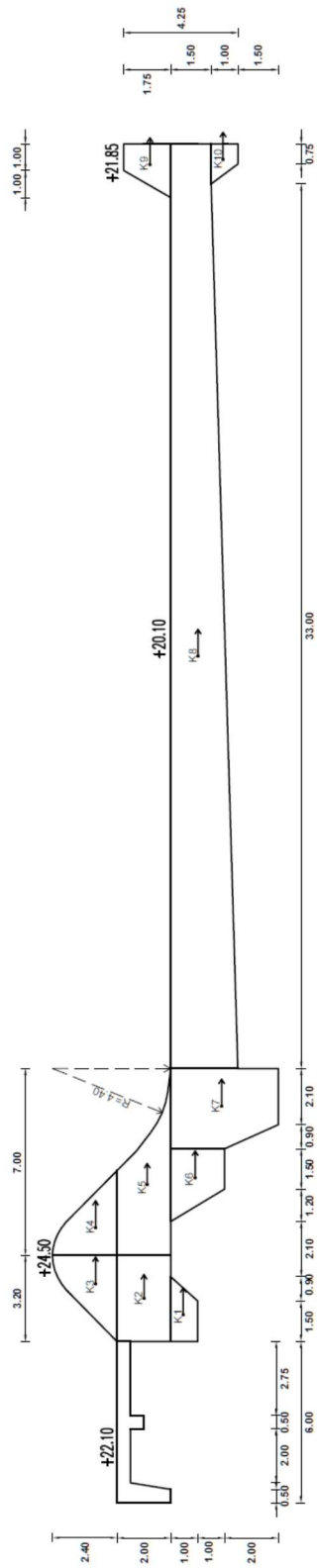

GAYA GEMPA

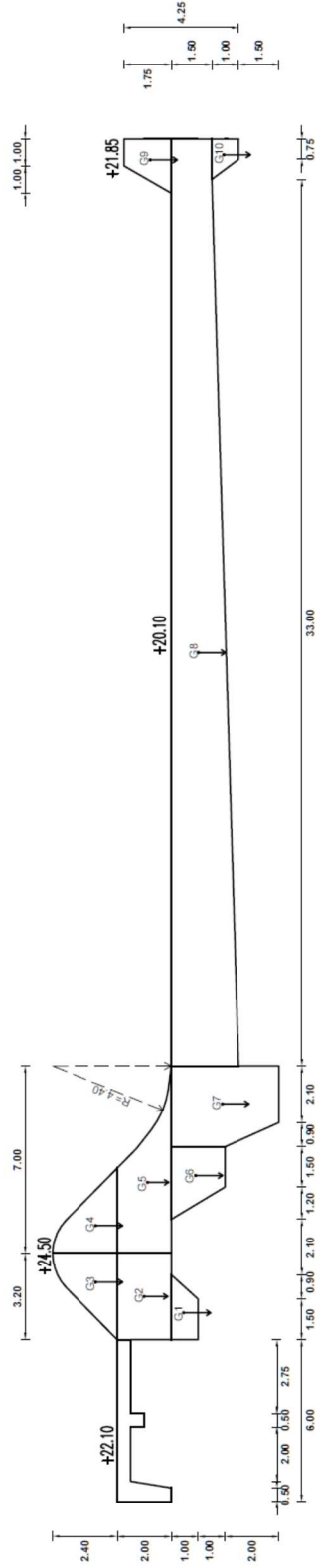

BERAT SENDIRI BENDUNG



Lampiran 6. Gaya uplift

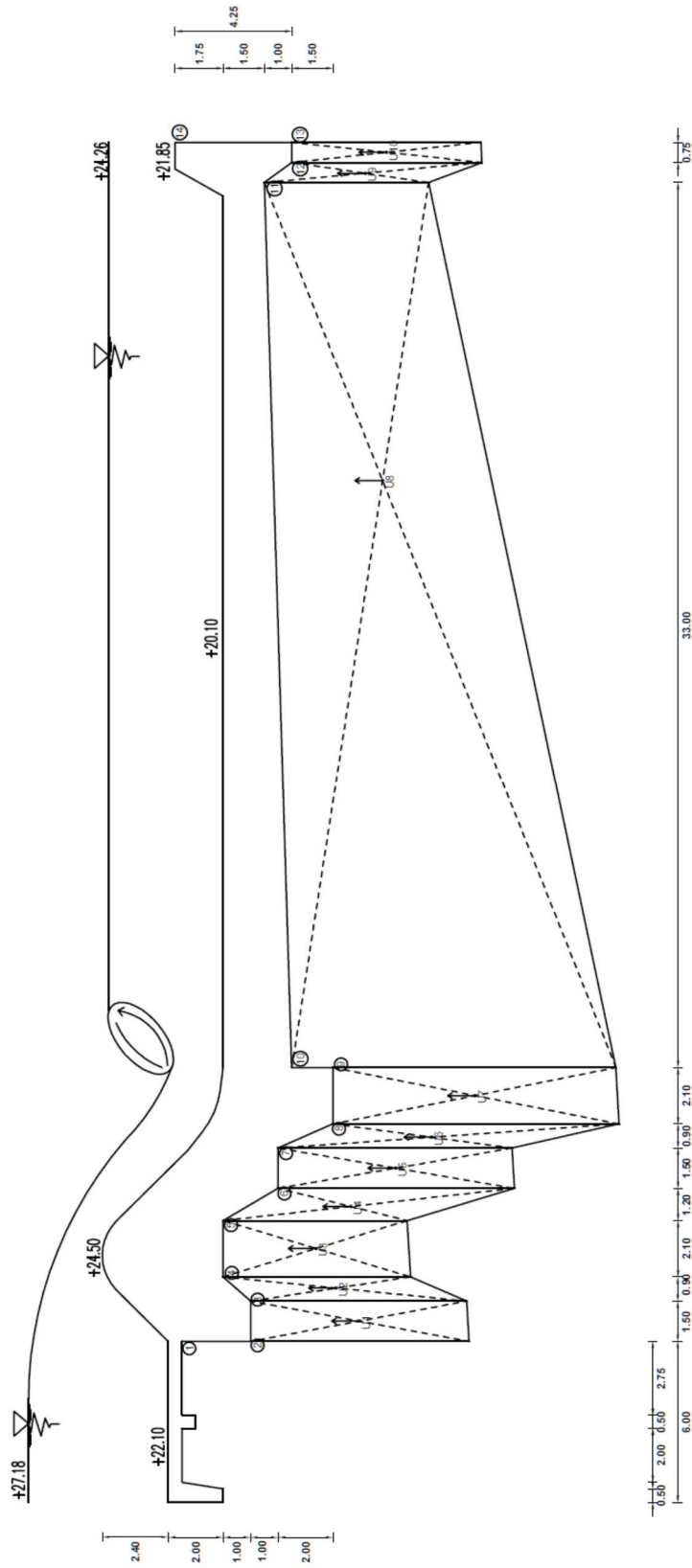

GAYA UPLIFT BENDUNG

Lampiran 7. Gaya berat air di atas bendung dan tekanan tanah

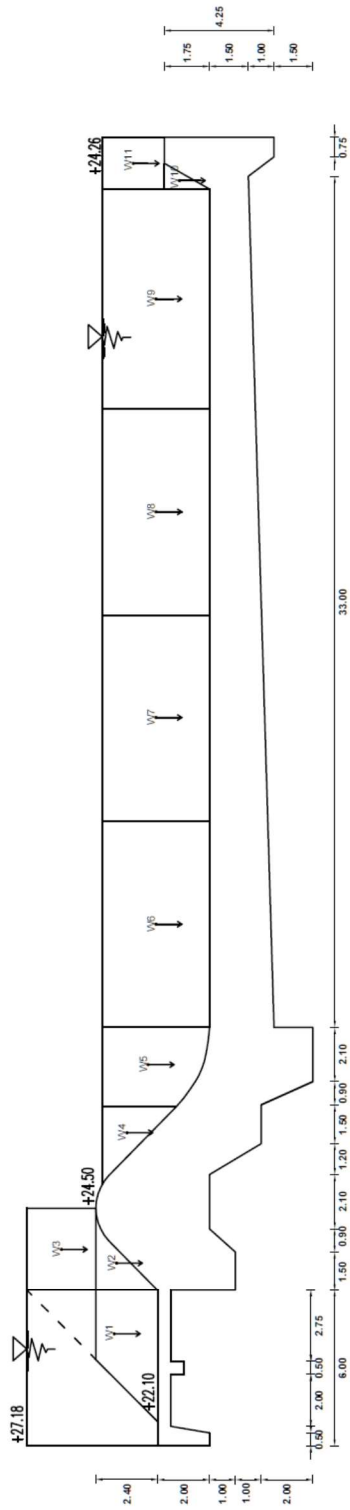

BERAT AIR DI ATAS BENDUNG

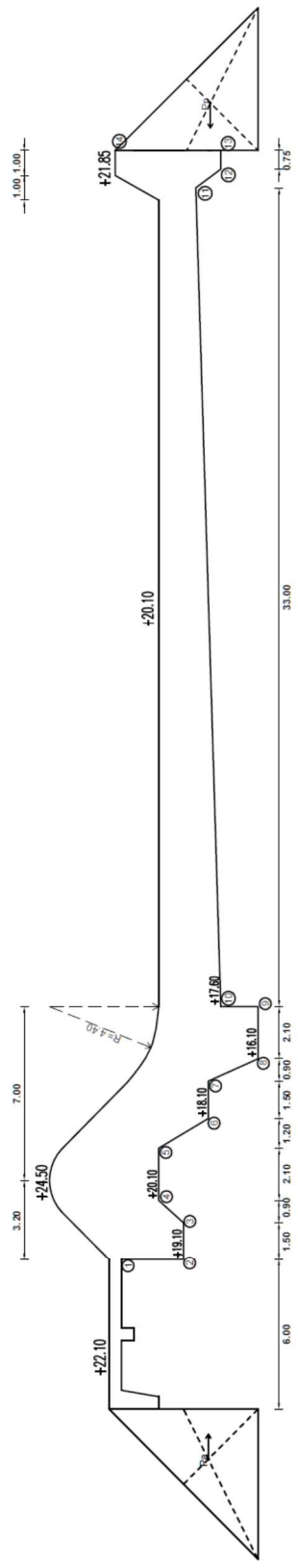

TEKANAN TANAH

Lampiran 8. Tekanan air di hulu dan hilir bendung dan tekanan lumpur

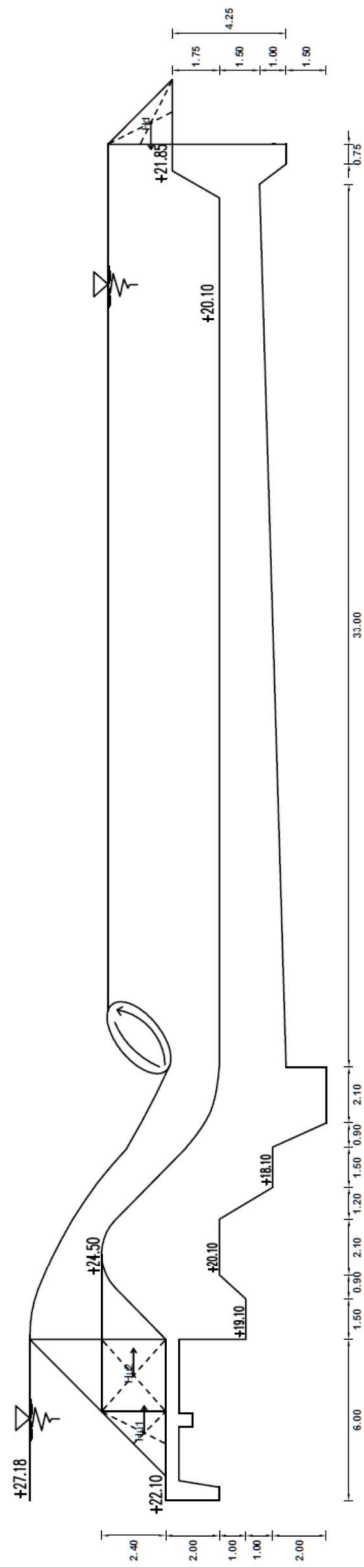

TEKANAN AIR DI HULU DAN HILIR BENDUNG

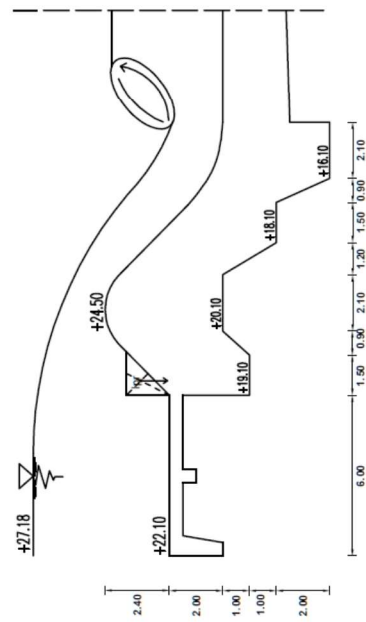

TEKANAN LUMPUR

